

TECHNICAL NOTE 30

Design Guidelines for Quartz Crystal Oscillators

Introduction

A CMOS Pierce oscillator circuit is well known and is widely used for its excellent frequency stability and the wide range of frequencies over which they can be used. They are ideal for small, low current and low voltage battery operated portable products especially for low frequency applications. [1,2] When designing with miniaturized quartz crystals, careful consideration must be given to the frequency, gain and crystal drive level.

In this paper, the design equations used in a typical crystal controlled pierce oscillator circuit design are derived from a closed loop and phase analysis. The frequency, gain and crystal drive current equations are derived from this method.

Basic Crystal Oscillator

The basic quartz crystal CMOS Pierce oscillator circuit configuration is shown on Figure 1. The crystal oscillator circuit consists of an amplifying section and a feedback network. For oscillation to occur, the Barkhausen criteria must be met

- a) The loop gain must be equal to or greater than one, and
- b) The phase shift around the loop must be equal to an integral multiple of 2π .

The CMOS inverter provides the amplification and the two capacitors, C_D and C_G , and the crystal work as the feedback network. R_A stabilizes the output voltage of the amplifier and is used to reduce the crystal drive level.

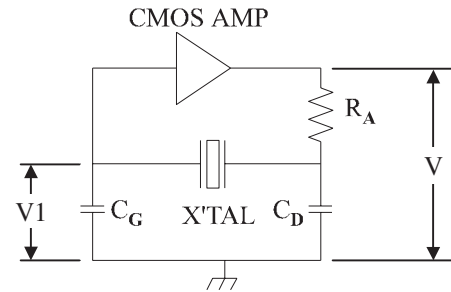
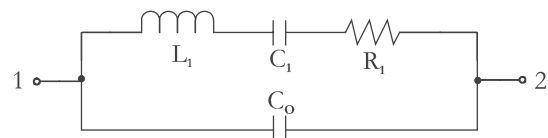

Figure 1 - Basic Pierce Oscillator Circuit

Crystal Characteristics

In order to analyze the quartz crystal oscillator, we must first understand the crystal itself. Figure 2 shows the electrical equivalent circuit of a quartz crystal. The L_1 , C_1 and R_1 are generally referred to as the electrical equivalent of the mechanical parameters; inertia, restoring force and friction, respectively. These parameters can be measured using a crystal impedance meter or a network analyzer. C_0 is the shunt capacitance between terminals and the sum of the electrode capacitance of the crystal and package capacitance.



R_1 Motional Resistance L_1 Motional Inductance
 C_1 Motional Capacitance C_0 Shunt Capacitance

Figure 2 – Crystal Electrical Equivalent Circuit

This equivalent circuit can effectively be simplified as a resistance (R_e) in series with a reactance (X_e) at a frequency f as shown in Figure 3.



Figure 3 - Effective Electrical Circuit of a Quartz Crystal

$R_e(f)$ and $X_e(f)$ as a function of frequency are as follows:

$$R_e(f) = \frac{R_1}{\left(\frac{R_1}{X_0}\right)^2 + \left(\frac{X_m}{X_0} - 1\right)^2} \quad (1)$$

$$X_e(f) = \frac{X_m \left(1 - \frac{X_m}{X_0} - \frac{R_1^2}{X_m X_0}\right)}{\left(\frac{R_1}{X_0}\right)^2 + \left(\frac{X_m}{X_0} - 1\right)^2} \quad (2)$$

where $X_0 = \frac{1}{\omega C_0}$ (3)

$$X_m = \omega L_1 - \frac{1}{\omega C_1}$$

The series resonant frequency of the crystal is defined as

$$f_s = \frac{1}{2\pi \sqrt{L_1 C_1}} \quad (4)$$

$$\omega_s = \frac{1}{\sqrt{L_1 C_1}}$$

The quality factor Q is defined as

$$Q = \frac{\omega_s L_1}{R_1} = \frac{1}{\omega_s R_1 C_1} \quad (5)$$

From equation (1) and (2), an example of the magnitude of R_e and X_e as a function of frequency are shown in Figures 4 and 5 respectively for $f_s=32.768\text{kHz}$, $C_1=2.4\text{fF}$, and $R_1=28\text{k}\Omega$. The frequency is expressed in terms of part per million (ppm) above the series resonant frequency (f_s) of the crystal ($\Delta f/f$). These two graphs are very useful in the analysis of the crystal oscillator.

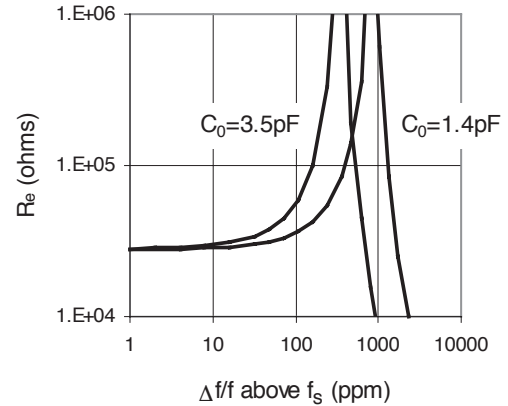

Figure 4 - R_e (ohms) vs. $\Delta f/f$ (ppm)

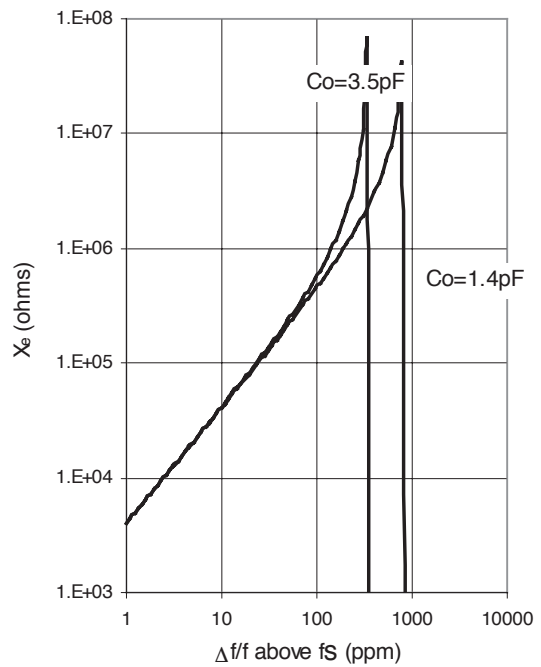

Figure 5 - X_e (ohms) vs. $\Delta f/f$

Crystal Oscillator Design

The AC equivalent circuit of the amplifier and feedback network of a pierce oscillator is shown in Figure 6. For the following analysis, R_A is omitted and will be reintroduced later.

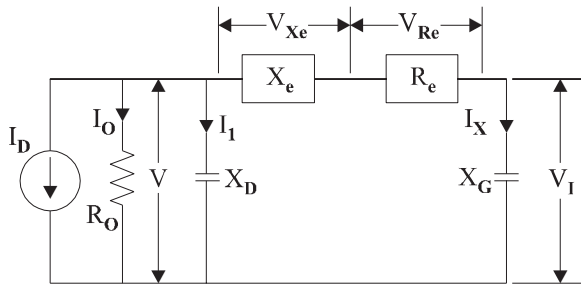

Figure 6 - Pierce Oscillator AC Equivalent Circuit

From Figure 6; $I_O = \frac{V}{R_O}$, $I_1 = \frac{V}{X_D}$,
 $I_D = g_m X_G I_X$, $X_D = \frac{1}{\omega C_D} = \frac{1}{2\pi f C_D}$ and
 $X_G = \frac{1}{\omega C_G} = \frac{1}{2\pi f C_G}$

The phase and amplitude relationship of the oscillator voltage, current and impedance are shown in Figures 7 and 8. Assume that the oscillator is oscillating at a frequency f and the amplifier output current I_D is 180° out of phase with the oscillator input voltage V_1 .

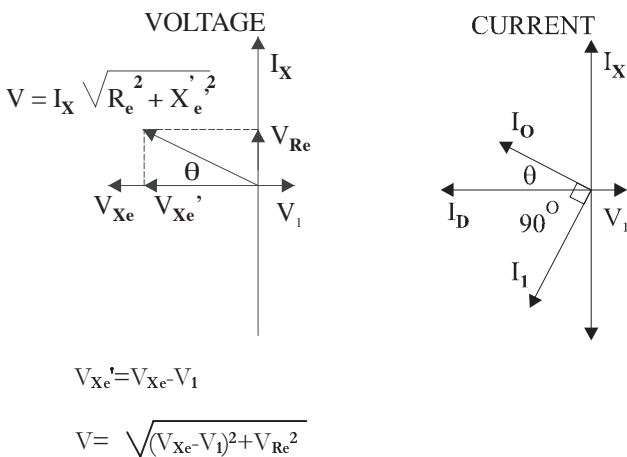
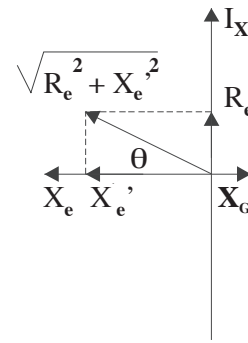

Figure 7 - Current and Voltage Phase Diagram



$X_e' = X_e - X_G$
 $\sin\theta = \frac{R_e}{\sqrt{R_e^2 + X_e'^2}}$, $\cos\theta = \frac{X_e'}{\sqrt{R_e^2 + X_e'^2}}$

Figure 8 - Impedance Phase Diagram

Frequency Equation

From the imaginary part of the current phase diagram (y-axis)

$I_1 \cos\theta = I_X + I_O \sin\theta$ (6)

and from the equations derived from the equivalent circuit, the voltage and impedance phasor diagram equation (6) becomes

$\frac{X_e'}{X_D} \cdot I_X = I_X + I_X \cdot \frac{R_e}{R_O}$

from $X_e' = X_e - X_G$

$X_e = X_D \left(1 + \frac{R_e}{R_O} \right) + X_G$

Then $X_e = \frac{1}{\omega C_D} \left(1 + \frac{R_e}{R_O} \right) + \frac{1}{\omega C_G}$ (7)

Assuming

$\left(\frac{R_1}{X_O'} \right)^2 \ll \left(\frac{X_m}{X_O} - 1 \right)^2$ and $\left| \frac{R_1}{X_m X_O'} \right| \ll \left| \frac{X_m}{X_O} - 1 \right|$

Equation (2) becomes

$$X_e(f) = \frac{X_m}{1 - \frac{X_m}{X_o'}} \quad (7a)$$

where $X_o' = \frac{1}{\omega C_o'}$ and $C_o' = C_o + C_s$.

C_s is the circuit stray capacitance across the crystal.

Let $X_{C_L'} = \frac{1}{\omega C_L'} = \frac{1}{\omega C_D} \left(1 + \frac{R_e}{R_o}\right) + \frac{1}{\omega C_G}$ (7b)

and $C_L' = \left\{ \frac{1}{C_D} \left(1 + \frac{R_e}{R_o}\right) + \frac{1}{C_G} \right\}^{-1}$.

From eq. 7a and 7b one can obtain

$$X_m X_o' = X_{C_L'} (X_o' - X_m)$$

$$X_m = \frac{X_{C_L'} X_o'}{X_o' + X_{C_L'}}$$

Then $X_m = \frac{1}{\omega(C_o' + C_L')}$ (8)

From eq. (3) and (4)

$$X_m = \omega L_1 - \frac{1}{\omega C_1} = \frac{1}{\omega C_1} \left\{ \frac{(\omega - \omega_s)(\omega + \omega_s)}{\omega_s^2} \right\}$$

$$X_m = \frac{2(\omega - \omega_s)}{\omega^2 C_1}$$

From equation (8)

$$\frac{2(\omega - \omega_s)}{\omega^2 C_1} = \frac{1}{\omega(C_o' + C_L')}$$

$$f - f_s = \frac{f_s C_1}{2(C_o' + C_L')}$$

$$f = f_s \left\{ 1 + \frac{C_1}{2(C_o' + C_L')} \right\} \quad (9)$$

$$C_o' = C_o + C_s$$

C_o : Crystal Shunt Capacitance

C_s : Total Stray Capacitance
Across the Crystal

Then $f = f_s \left\{ 1 + \frac{C_1}{2(C_o' + C_L')} \right\}$ (10)

where $C_L = C_s + C_L'$.

Equation 10 is the oscillating frequency of the crystal oscillator. C_L is called the load capacitance of the oscillator. With a specified C_L , the crystal manufacturer can then match the crystal to the customer's circuit to obtain the desired oscillation frequency. From the C_L equation, the relationship between the other circuit parameters can be established (i.e. C_D , C_G , R_o and C_s) as it relates to the oscillation frequency of the crystal oscillator.

In a typical CMOS oscillator R_o generally decreases as the supply voltage increases. This causes a decrease in load capacitance and an increase in the oscillation frequency.

Figure 9 shows the effective load capacitance (C_L) changes as the output resistance (R_o) changes.

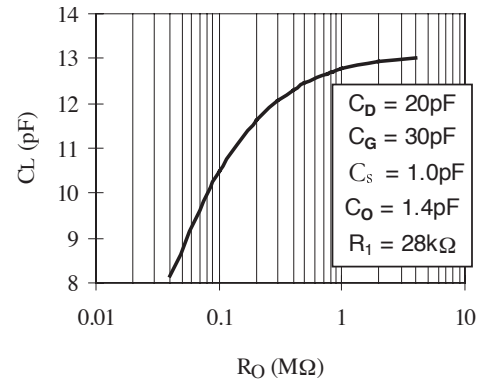

Figure 9 - Effective Load Capacitance (C_L) vs. Output Resistance (R_o)

Gain Equation

From the real part of the current phase diagram (x-axis);

$$I_D = I_O \cos \theta + I_1 \sin \theta \quad (11)$$

and from the equation derived from the voltage, and impedance phase diagram equation (11) becomes

$$\begin{aligned} g_m X_G I_X &= \frac{I_X \sqrt{R_e'^2 + X_e'^2}}{R_O} \cdot \frac{X_e'}{\sqrt{R_e'^2 + X_e'^2}} \\ &+ \frac{I_X \sqrt{R_e'^2 + X_e'^2}}{X_D} \cdot \frac{R_e}{\sqrt{R_e'^2 + X_e'^2}} \\ &= I_X \frac{X_e'}{R_O} + I_X \frac{R_e}{X_D} \\ g_m X_G &= \frac{X_e'}{R_O} + \frac{R_e}{X_D} \end{aligned}$$

$$g_m = \frac{R_e}{X_D X_G} + \frac{X_e'}{R_O X_G}, \text{ and from } X_e' = X_e - X_G \text{ and}$$

eq. (7)

$$\begin{aligned} g_m &= \frac{R_e}{X_D X_G} + \frac{1}{R_O X_G} \left[X_D \left(1 + \frac{R_e}{R_O} \right) \right] \\ g_m &= 4\pi^2 f^2 C_D C_G R_e + \frac{C_G}{C_D R_O} \left(1 + \frac{R_e}{R_O} \right) \quad (12) \end{aligned}$$

where $R_e \approx R_1 \left(1 + \frac{C_O'}{C_L} \right)^2$

Equation (12) gives the minimum g_m required for the oscillator to maintain oscillation. In practice, 5 to 10 times the calculated value is required to insure fast start of oscillation. This equation also aids the designer in selecting the component values for C_D and C_G to match the CMOS amplifier and the crystal.

It is important to note here that in most analyses, only the first term of equation (12) is used. The second term must be taken into account especially for low frequency application were the second term becomes larger than the first term as shown in Figure 10, when R_O is less than 1.2 MΩ.

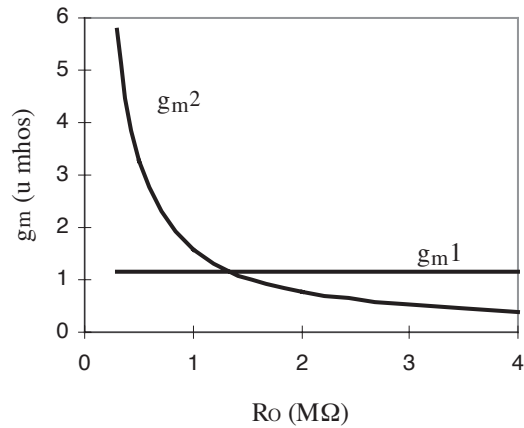

Figure 10 - Comparison of minimum gm requirements vs. Amplifier's output resistance (R_O).

Where

g_{m1} = first term and g_{m2} = 2nd term of equation(12).

For $C_D=20pF$, $C_G=30pF$, $C_S=1.1pF$, $C_O=1.4pF$, $R_1=28K\Omega$, $f_o=32.768kHz$ and $C_L=13pF$.

Using equation (12), Figures 11 and 12 show the change in the minimum g_m requirements due to change in either C_D or C_G , while maintaining the other capacitor constant. For a 32.768kHz oscillator, as shown in Figure 11, trimming the output capacitor (C_G) will produce more change in g_m than the input capacitor (C_D). As shown in Figure 12, a decrease in the amplifiers' output resistance (R_O) increases the minimum g_m requirement.

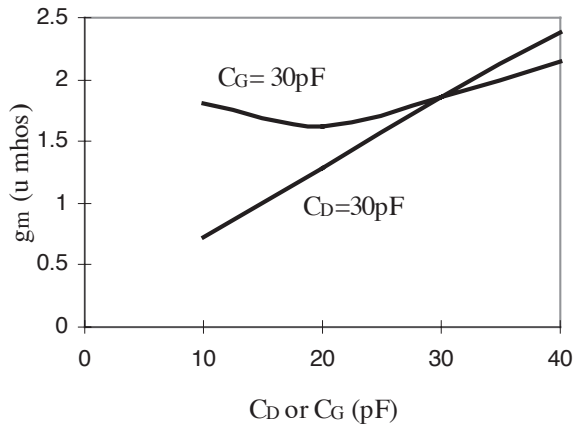

Figure 11 - For $R_O=2.5M\Omega$ g_m comparison between C_D and C_G , where $C_S=1.1pF$, $C_O=1.4pF$, $R_1=28K\Omega$, $f_O=32.768kHz$

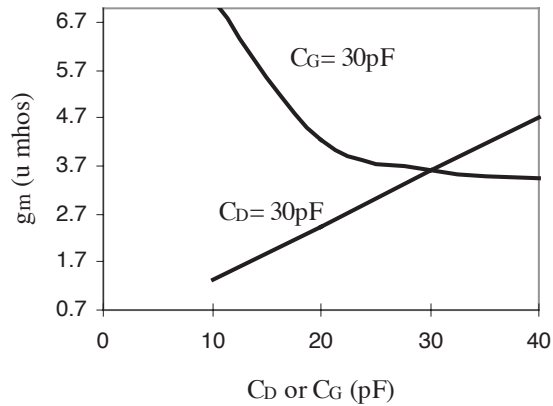

Figure 12 - For $R_O=500k\Omega$ g_m comparison between C_D and C_G , where $C_S=1.1pF$, $C_O=1.4pF$, $R_1=28K\Omega$, $f_O=32.768kHz$

Crystal Drive Current

In order to analyze the current flowing through the crystal, the AC equivalent circuit from Figure 6 is redrawn to show the crystal's electrical equivalent circuit as shown in Figure 13. The crystal drive current is i_b , and i_a is the current through the shunt capacitance C_O' .

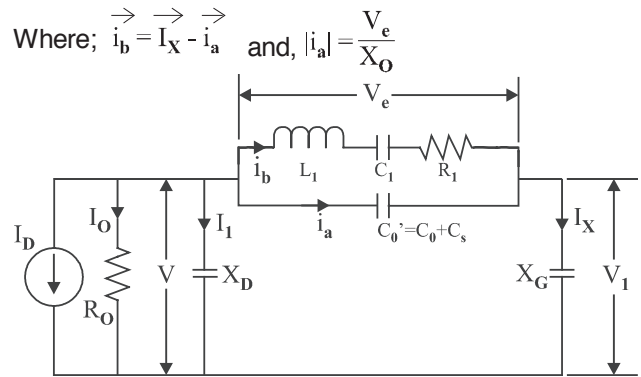

Figure 13 - Oscillator AC equivalent circuit with the crystal electrical equivalent circuit.

The crystal voltage, current and impedance phase relationships are shown in Figure 14 and 15;

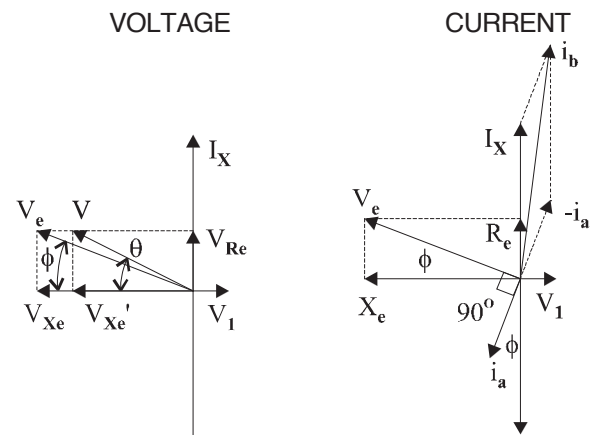

Figure 14 - Voltage and current phase relationship with the circuit equivalent

CRYSTAL IMPEDANCE

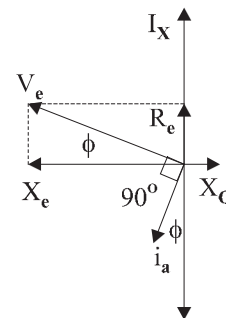

Figure 15 - Crystal impedance phase diagram

From; $i_a = \frac{V_e}{X_O}$, and, $V_e = I_X \sqrt{(R_e^2 + X_e^2)}$

$$i_a = \frac{I_X \sqrt{(R_e^2 + X_e^2)}}{X_O'} \quad (13)$$

where $X_O' = \frac{1}{\omega(C_O')} = \frac{1}{\omega(C_O' + C_s)}$.

From the current phase diagram of Figure 14 and the relationship $\vec{i}_b = \vec{I}_X - \vec{i}_a$

$$i_b = \sqrt{(I_X + i_a \cos \phi)^2 + (i_a \sin \phi)^2}$$

and from the crystal impedance phase diagram Figure 15

$$\sin \phi = \frac{R_e}{\sqrt{R_e^2 + X_e^2}}; \quad \cos \phi = \frac{X_e}{\sqrt{R_e^2 + X_e^2}}$$

Substituting $\sin \phi$ and $\cos \phi$ and i_a from equation (13)

$$i_b = \left\{ I_X^2 \left(1 + \frac{\sqrt{R_e^2 + X_e^2}}{X_O} \cdot \frac{X_e}{\sqrt{R_e^2 + X_e^2}} \right)^2 + I_X^2 \frac{(R_e^2 + X_e^2)}{X_O^2} \cdot \frac{R_e^2}{R_e^2 + X_e^2} \right\}^{\frac{1}{2}}$$

$$\text{or } i_b = I_X \left\{ \left(1 + \frac{X_e}{X_O} \right)^2 + \left(\frac{R_e}{X_O} \right)^2 \right\}^{\frac{1}{2}}$$

Substituting; $|I_X| = \frac{|V|}{\sqrt{R_e^2 + X_e^2}}$

$$i_b = \frac{|V|}{\sqrt{(R_e^2 + X_e^2)}} \sqrt{\left(1 + \frac{X_e}{X_O} \right)^2 + \left(\frac{R_e}{X_O} \right)^2} \quad (14)$$

where $X'_e = X_e - X_G$

From eq. (14) the crystal drive can be calculated from;

$$P = i_b^2 R_1 \quad (\text{in Watts})$$

where R_1 = crystal's motional resistance.

Typical Effects Of R_A In The Oscillator Circuit

In many cases, a resistor R_A is introduced between the amplifier output terminal and the crystal input terminal as shown in Figure 1. The use of R_A will increase the frequency stability, since it provides a stabilizing effect by reducing the total percentage change in the amplifier output resistance R_O and also increases the effective output impedance by R_A as shown on Figure 9. R_A also stabilizes the output voltage of the oscillator and is used to reduce the drive level of the crystal.

The complete AC equivalent circuit of Figure 1 is shown in Figure 16, where X_d is the total output capacitance of the amplifier.

Using the same analytical approach, the frequency, gain and crystal drive current equations with R_A are derived.

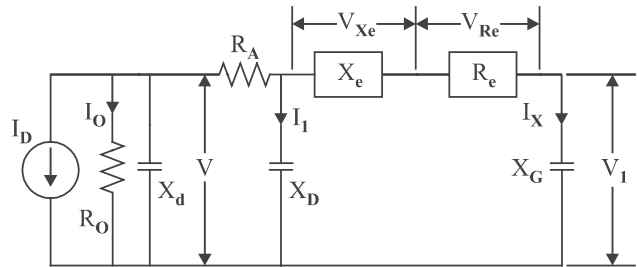

Figure 16 - Pierce oscillator AC equivalent circuit with R_A included

From the frequency equation (10);

$$f = f_s \left\{ 1 + \frac{C_1}{2(C_O + C_L)} \right\} \quad (10)$$

where; $C_L = C_S + C_L'$
and,

$$\frac{1}{C_L'} = \frac{1}{C_D \left(1 + \frac{R_A}{R_O} \right) + C_d} \left(1 + \frac{R_A + R_e}{R_O} - R_A R_e \omega^2 C_d C_D \right) + \frac{1}{C_G}$$

The gain equation is;

$$g_m \geq 4\pi^2 f^2 C_G \left[(C_D + C_d) R_e + \left(C_d + \frac{R_e}{R_O} C_d \right) R_A \right]$$

$$+ \frac{C_G}{C_D \left(1 + \frac{R_A}{R_O}\right) + C_d} \left(4\pi^2 f^2 C_d C_D R_A + \frac{1}{R_O}\right) \left(1 + \frac{R_A + R_e}{R_O} - 4\pi^2 f^2 C_d C_D R_A R_e\right)$$

where $R_e \approx R_1 \left(1 + \frac{C_{O'}}{C_L'}\right)^2$

The crystal drive current;

$$i_b = \frac{|V| \sqrt{\left(1 + \frac{X_e}{X_O}\right)^2 + \left(\frac{R_e}{X_O}\right)^2}}{\sqrt{\left[R_e + R_A \left(1 - \frac{X_e'}{X_O}\right)\right]^2 + \left[X_e' + R_A \frac{R_e}{X_D}\right]^2}}$$

where $X_e' = X_e - X_G$ and, $R_e \approx R_1 \left(1 + \frac{C_{O'}}{C_L'}\right)^2$.

Summary

By using the closed loop and phase diagram method, we were able to derive the frequency, gain and crystal drive current equations for a simple quartz crystal pierce oscillator. From the equations derived herein, it can be shown that the stray capacitance, minimum gain requirements and the output resistance of the amplifier must be carefully considered to obtain optimum oscillator performance. The minimum gain requirements should include consideration for the full range of operational temperature and voltage. The stray capacitance (C_s) is especially critical due to negative feedback effects and will increase the minimum gain requirements of the oscillator [1]. As crystal manufacturers continue to miniaturize the crystal resonator, the oscillator designer must take into account the trade off in the crystal, amplifier and the circuit layout strays in order to select the appropriate component values to achieve proper crystal drive, start up, and a stable oscillation.

References:

[1] S.S. Chuang and E. Burnett, "Analysis of CMOS Quartz Oscillator", Proc. 9th Int. Congress Chronometry (Stuttgart, W. Germany), Sept. 1974 paper C2.2
 [2] E. Vittoz, "High-Performance Crystal Oscillator circuits: Theory and Application" IEEE Journal of Solid state circuits, vol. 23, No. June 1988 pp.774-783.

A version of this paper was presented at the 18th Piezoelectric Devices Conf. in Aug. 1996 by Jim Varsovia