

**Customer Part:**
**Description**

- Standard 3.2 x 2.5mm SMD crystal in a ceramic package with a seam sealed metal lid, hermetically sealed.
- Model CFPX-180
- Model Issue number 11

**Frequency Parameters**

- Frequency 30.0MHz
- Frequency Tolerance  $\pm 20.00\text{ppm}$
- Tolerance Condition @ 25°C
- Frequency Stability  $\pm 30.00\text{ppm}$
- Operating Temperature Range -40.00 to 85.00°C
- Overtone Order Fundamental
- Ageing  $\pm 5\text{ppm}$  max per year @ 25°C

**Electrical Parameters**

- Load Capacitance (CL) 18.00pF
- Shunt Capacitance (C0) 7pF max
- Drive Level 100µW max
- ESR 40.00Ω max

**Environmental Parameters**

- Storage Temperature Range: -55 to 125°C
- Shock: MIL-STD-202F, Method 213B: 1000g, 0.5ms, 1/2 sine wave
- Vibration: MIL-STD-202F, Method 204D, Test Condition D: 20g (10Hz-2000Hz), 4hrs in 3 mutually perpendicular planes (total 12hrs)

**Manufacturing Details**

- RoHS Terminations NiAu
- RoHS Reflow Temp 260degC 10s

**Compliance**

- RoHS Status (2015/863/EU) Compliant
- REACH Status Compliant
- MSL Rating (JDEC-STD-033): Not Applicable

**Packaging Details**

- Tape & reel in accordance with EIA-481
- Quantities below the standard reel size to be supplied on cut tape.
- Standard Quantity: 3,000 Pieces

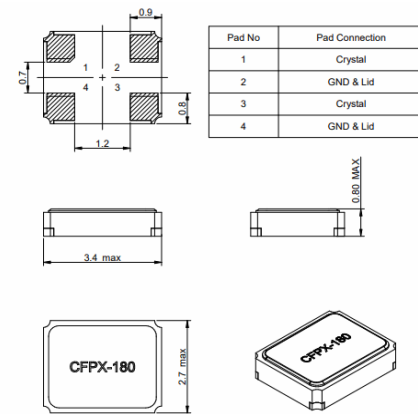
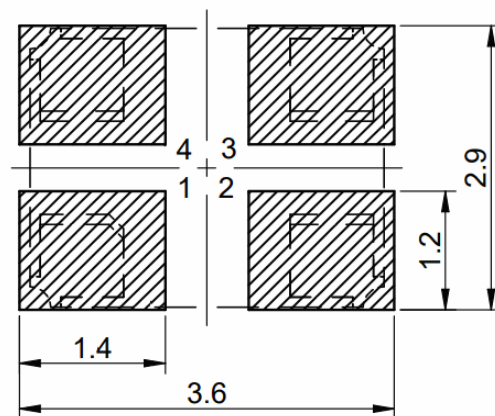
**Outline (mm)**

**Recommended Solder Pad Layout**

**Sales Office Contact Details:**

UK: +44 (0)1460 270200

USA: +1.760 668 8935

 Email: [info@iqdfrequencyproducts.com](mailto:info@iqdfrequencyproducts.com)

 Web: [www.iqdfrequencyproducts.com](http://www.iqdfrequencyproducts.com)