

ISSUE 5; July 2024

Description

- Suitable for real time clock applications
32.768kHz output crystal oscillators
Ceramic package with a seam sealed metal lid, hermetically sealed



Frequency Parameters

- Frequency 32.768kHz
- Frequency Stability $\pm 20.00\text{ppm}$ to $\pm 100.00\text{ppm}$
- Ageing $\pm 3\text{ppm}$ max per year

Electrical Parameters

- Supply Voltage 2.5V $\pm 5\%$

Operating Temperature Ranges

- 0 to 70°C
- -40 to 85°C

Output Details

- Output Compatibility CMOS
- Drive Capability 15pF max

Output Control

- Standby Operation:
Logic '1' to pad 1 enables oscillator output
Logic '0' to pad 1 disables oscillator output; when disabled the oscillator output goes to the high impedance state
No connection to pad 1 enables oscillator output
- Start-up Time: 35ms max
2ms typ to 90% of final amplitude (under ideal conditions @ 25°C)
- Standby Current: 10µA max, 1.35µA typ @ 25°C

Environmental Parameters

- Storage Temperature Range: -55 to 125°C
- Shock: MIL-STD-883F, Method 2002.4: 1500G, 0.5ms, 3 times in each of 3 mutually perpendicular planes.
- Vibration: MIL-STD-883F, Method 2007.3: 20G (20Hz-2000Hz), 1.52mm amplitude

Manufacturing Details

- RoHS Terminations NiAu
- RoHS Reflow 260degC 10s

Ordering Information

- Frequency*
Model*
Output
Frequency Stability*
Operating Temperature Range*
Supply Voltage
- Example
32.768kHz CFPS-108
CMOS $\pm 50\text{ppm}$ 0 to 70C 2.5V

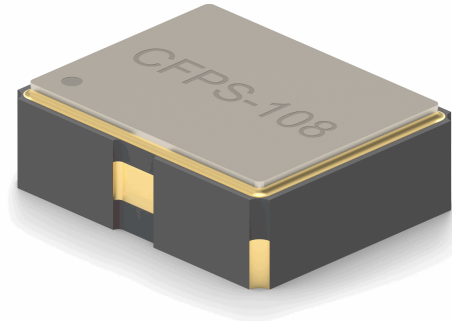

Outline (mm)

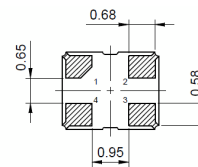

- Pad Connections
1. Tristate
 2. GND
 3. Output
 4. +Vs

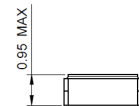
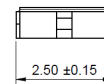

Recommended Solder Pad Layout

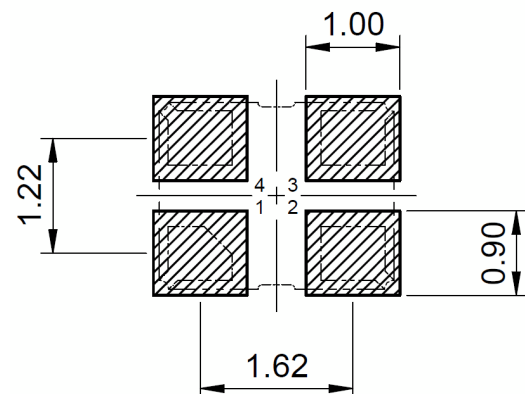

Sales Office Contact Details:

UK: +44 (0)1460 270200

Email: info@iqdfrequencyproducts.com

Web: www.iqdfrequencyproducts.com

Compliance

- RoHS Status (2015/863/EU) Compliant
- REACH Status Compliant
- MSL Rating (JDEC-STD-033): Not Applicable

Packaging Details

- Pack Style: Cutt In tape, cut from a reel
Standard Pack Quantity: 100
- Pack Style: RL3K Tape & reel in accordance with EIA-481
Standard Pack Quantity: 3,000
- Pack Style: Reel Tape & reel in accordance with EIA-481
Standard Pack Quantity: 1,000

Test Circuit

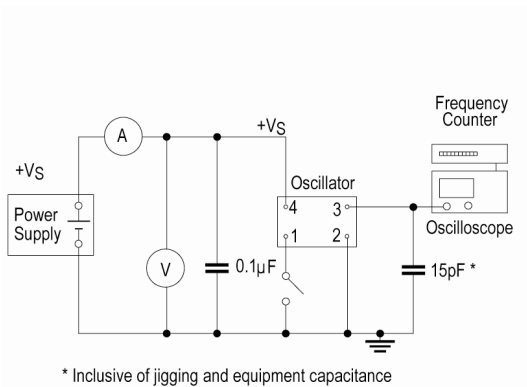

Wave Form

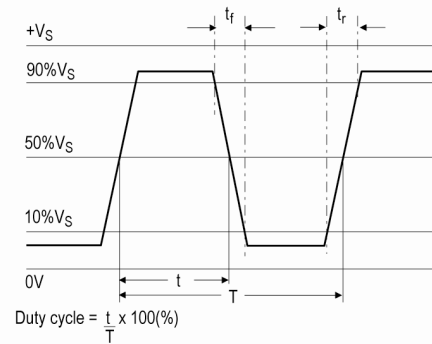

Electrical Specification - maximum limiting values 2.50V ±5%

Frequency Min	Temperature Range	Stability (Min)	Current Draw	Rise and Fall Time	Duty Cycle
	°C	ppm	mA	ns	%
32.768kHz	-40 to 85	±25.00	2.5	50	40/60%
	0 to 70	±20.00	2.5	50	40/60%

This document was correct at the time of printing; please contact your local sales office for the latest version.
[Click to view latest version on our website.](#)

Sales Office Contact Details:

UK: +44 (0)1460 270200

Email: info@iqdfrequencyproducts.com

Web: www.iqdfrequencyproducts.com