

ISSUE 7; September 2020

Description

- Surface mount temperature compensated voltage controlled crystal oscillators for medium to high volume applications where small size and high performance are prerequisites. Capable of sub 0.3ppm performance over an extended temperature range. Its ability to function down to a supply voltage of 2.4V and low power consumption makes it particularly suitable for mobile applications.
- -A Freq Adj option
- Option A (standard):
Ageing adjustment by means of external Control Voltage applied to pad 1
Range (frequency \leq 20MHz) $\geq \pm 5$ ppm
Range (frequency $>$ 20MHz) $\geq \pm 7$ ppm
Linearity $\leq 2\%$
Slope Positive
Input resistance $\geq 100k\Omega$
Modulation bandwidth $\geq 2kHz$
Standard control voltage range $1.5V \pm 1V$
- -B No Freq Adj
- Option B: No frequency adjustment
Initial Calibration $\leq \pm 1.0$ ppm

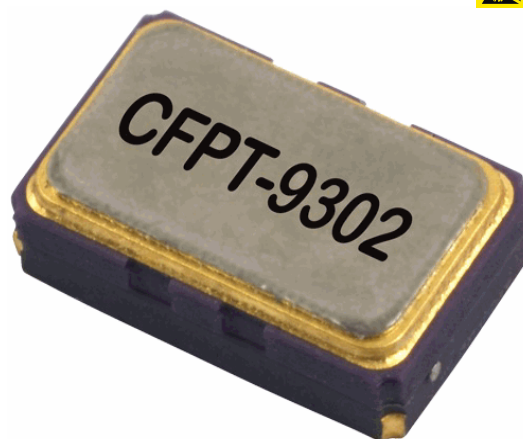

Frequency Parameters

- Frequency 12.0MHz to 52.0MHz
- Frequency Tolerance ± 1.00 ppm
- Frequency Stability ± 0.20 ppm to ± 2.00 ppm
- Ageing ± 2 ppm max in 1st year (see Note 1)
- Supply Voltage Variation (@ $\pm 5\%$ change): ± 0.05 ppm typ
- Load Variation (@ $\pm 10\%$ change): ± 0.05 ppm typ
- Note 1 Ageing:
Frequency ≤ 20 MHz: ± 1 ppm max in 1st year
Frequency ≤ 20 MHz: ± 3 ppm max for 10 years (including the 1st year)
Frequency > 20 MHz: ± 2 ppm max in 1st year
Frequency > 20 MHz: ± 5 ppm max for 10 years (including the 1st year)

Electrical Parameters

- Supply Voltage $3.0V \pm 10\%$
- Supply Current (typical):
Clipped Sinewave: $1 + \text{Frequency}(\text{MHz}) * 1.2 * \{\text{Load}(\text{pF}) + 30\} * 1E-3$ mA
i. e. @ 20MHz, 10pF ≈ 2 mA
Calculation: $1 + (20 \times 1.2 \times (10 + 30) \times 0.001) = 1.96$ mA
- Supply Voltage Tolerance: Parts will operate correctly with $\pm 10\%$ supply voltage variation but supply coefficient is measured with $\pm 5\%$ variation

Frequency Adjustment

- Pulling ± 5 ppm min (see Note 1)

Operating Temperature Ranges

- -20 to 70°C
- -40 to 85°C

Outline (mm) -B = No Freq Adj

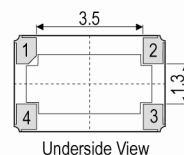
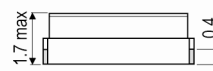
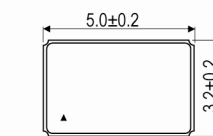

- Pad Connections
1. Voltage Control (Option A) or NC (Option B)
 2. GND
 3. Output
 4. +Vs

Solder Pad Layout

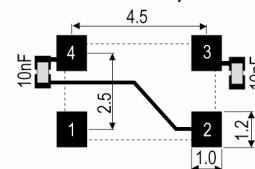

Sales Office Contact Details:

UK: +44 (0)1460 270200
Germany: 0800 1808 443

France: 0800 901 383
USA: +1.760.318.2824

Email: info@iqdfrequencyproducts.com
Web: www.iqdfrequencyproducts.com

Output Details

- Output Compatibility Clipped Sine
- Drive Capability 10k Ω //10pF, DC coupled
- Output Level: 0.8Vpk-pk min

Environmental Parameters

- Storage Temperature Range: -55 to 125°C
- Shock: IEC 60068-2-27, Test Ea: 1500G acceleration for 0.5ms, 3 shocks in each of 3 mutually perpendicular planes
- Vibration: IEC 60068-2-6, Test Fc: 10-60Hz 1.5mm displacement, 60-2000Hz at 20G, 4 hours in each of three mutually perpendicular axes at 1 oct/min
- RoHS Terminations NiAu

Ordering Information

- Frequency*
Model*
Frequency Adjustment Option*
Output
Frequency Stability (over operating temperature range)*
Operating Temperature Range*
Supply Voltage
(*minimum required)
- Example
20.0MHz CFPT-9302-A
Clipped Sine \pm 1ppm-20 to 70C 3.0V
- Stability/Temperature Range combinations may not be available for all frequencies, please contact our sales offices
- Supply Voltages in the range 2.4V to 6.0V are available to order, please contact our sales offices
- Low profile option (1.4mm max height) is available, please contact our sales offices
- Non standard requirements may be available upon request, please contact our sales offices

Compliance

- RoHS Status (2011/65/EU) Compliant
- REACH Status Compliant
- MSL Rating (JDEC-STD-033): 3

Packaging Details

- Pack Style: Reel Tape & reel in accordance with EIA-481-D
Pack Size: 100
- Pack Style: Bulk Loose in bulk pack
Pack Size: 10

Sales Office Contact Details:

UK: +44 (0)1460 270200
Germany: 0800 1808 443

France: 0800 901 383
USA: +1.760.318.2824

Email: info@iqdfrequencyproducts.com
Web: www.iqdfrequencyproducts.com

Test Circuit

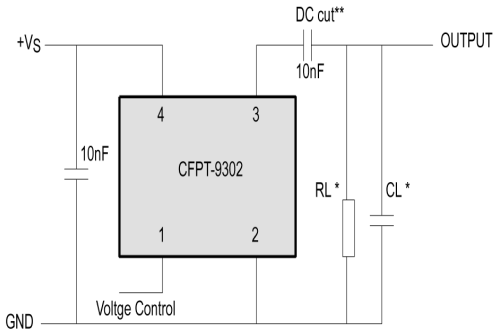

* Load 10kΩ // 10pF (clipped sinewave), inclusive of probe and jig capacitance
 ** DC cut capacitor required for AC coupled clipped sinewave

Typical Phase Noise at 14.4MHz

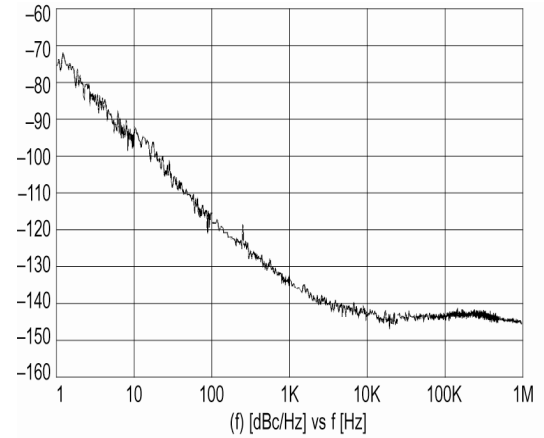

Electrical Specification - maximum limiting values 3.0V ±10%

Frequency Min	Frequency Max	Temperature Range	Stability (Min)	Current Draw	Rise and Fall Time	Duty Cycle
		°C	ppm	mA	ns	%
12.0MHz	52.0MHz	-20 to 70	±0.2	-	-	-
		-40 to 85	±0.3	-	-	-

This document was correct at the time of printing; please contact your local sales office for the latest version.
[Click to view latest version on our website.](#)

Sales Office Contact Details:

UK: +44 (0)1460 270200
 Germany: 0800 1808 443

France: 0800 901 383
 USA: +1.760.318.2824

Email: info@iqdfrequencyproducts.com
 Web: www.iqdfrequencyproducts.com